

ROTANODE E7876X

Rotating Anode X-Ray Tube Assembly

- ◆ Rotating anode X-ray tube assembly for high energy radiographic and cine-fluoroscopic operations.
- ◆ The heavy anode is constructed with specially processed rhenium-tungsten faced molybdenum target which is 74 mm diameter and has an improved coating to increase thermal emissivity.
- ◆ This tube has foci 1.2 and 0.6, and is available for a maximum tube voltage 150 kV.
- ◆ Accommodated with IEC60526 type high-voltage cable receptacles.



General Data

IEC Classification **Class I**

Electrical:

Circuit:

High Voltage Generator Constant potential high-voltage generator
 Grounding Center-grounded

Nominal Tube Voltage:

Radiographic Maximum 40 ~ 150 kV
 Fluoroscopic Maximum 50 ~ 125 kV

Nominal Focal Spot Value:

Large Focus 1.2
 Small Focus 0.6

Nominal Anode Input Energy (at 0.1s):

	50 Hz	60 Hz
Large Focus	50 kW	54 kW
Small Focus	20 kW	22 kW

★The information contained herein is presented only as a guide for the applications of our products.
 No Responsibility is assumed by TOSHIBA ELECTRON TUBES & DEVICES CO.,LTD.(TETD) for any infringements of patents or other rights of the third parties which may result from its use. No license is granted by implication or otherwise under any patent or patent rights of TETD or others.
 ★The information contained herein may be changed without prior notice. It is therefore advisable to contact TETD before proceeding with the design of equipment incorporating this product.
 ★For further particulars apply to TETD.

Motor Ratings Stator: XS-R

Duty		Starting	Running
Power source	(Hz)	50/60	50/60
Input power	(W)	1450	80
Voltage ¹⁾	(V)	240	58
Current	(A)	6.5	1.5
Min. Speed up ²⁾	(s)	0.6	-
Capacitor	(μ F)	24	24

Note 1) The every applied voltage must be never exceeded 110% of the above specification.

2) The speed-up time is allowed up to 110% of the above specification.

Anode Rotation Speed:

50 Hz Minimum 2700 min⁻¹

60 Hz Minimum 3200 min⁻¹

Stator impedance:

Common-Main Winding 27.5 Ω

Common-Auxiliary Winding 58.0 Ω

Resistance between Housing and Low Voltage Terminals Minimum 2 M Ω

Normal operating range of the housing temperature 16 ~ 75 °C

Mechanical:

Dimensions See dimensional outline

Overall Length 479 mm

Maximum Diameter 152.4 mm

Target:

Angle 12 degrees

Diameter 74 mm

Construction Rhenium-Tungsten faced Molybdenum

Permanent Filtration 1.3 mm Al / 75 kV IEC60522 / 1999

Radiation Protection (To meet the requirements of IEC60601-1-3):

Leakage Technique Factor 150 kV, 3.4 mA

X-ray Coverage 354 × 354 mm at SID 835 mm

Weight (Approx.) 16 kg

High Voltage Receptacle To meet requirements of IEC60526

Cooling Method Natural or forced air

Housing (Including both end plates):

Model Number XH-121

Absolute Maximum and Minimum Ratings

(At any time, these values must not be exceeded.)

Nominal X-ray Tube Voltage:

Radiographic	150 kV
Fluoroscopic	125 kV

Maximum Voltage to Ground 78 kV

Minimum Tube Voltage 40 kV

Maximum X-ray Tube Current:

Large Focus 700 mA

Small Focus 300 mA

Maximum Filament Current:

Large Focus 5.4 A

Small Focus 5.2 A

Filament Voltage:

Large Focus (At maximum filament current 5.4 A) 11.9 ~ 16.1 V

Small Focus (At maximum filament current 5.2 A) 6.8 ~ 9.2 V

Filament Frequency Limits 0 ~ 25 kHz

X-ray Tube Assembly Input Power 142 W (200 HU/s)

(Repeated radiographic exposure)

Thermal Characteristics:

Anode Heat Content 163 kJ (230 kHU)

Maximum Anode Heat Dissipation 750 W (1056 HU/s)

X-ray Tube Assembly Heat Content 900 kJ (1250 kHU)

Maximum Continuous Heat Dissipation:

Without Air-circulator 180 W (15 kHU/min)

Environmental Limits

Operating Limits:

Temperature 10 ~ 40 °C
Humidity 30 ~ 85 %
(No condensation)
Atmospheric Pressure 70 ~ 106 kPa

Shipping and Storage Limits:

Temperature -20 ~ 70 °C
Humidity 20 ~ 90 %
(No condensation)
Atmospheric Pressure 50 ~ 106 kPa

Warning

Warning to Interface with X-ray Generator

1. Housing Rupture

Never input over-rated power to x-ray tube assembly.

If the input power is extremely higher than specification, it may cause the over temperature of anode, insert tube glass shatter and ultimately the following serious problems due to generating over-pressure by oil vaporization inside housing assembly.

In such a critical condition, the safety thermal switch can not protect x-ray tube even if it works.

- * Housing sealing parts rupture
- * Human injury including burns due to hot oil escape
- * Fire accident due to flaming anode target

We strongly request that the x-ray generator should have a protective function which manages input power to x-ray tube assembly.

Cautions

Caution to Interface with X-ray Generator

1. Over Rating

X-ray tube assembly can be broken with applying just one over rated shot.
Please read the technical data sheets carefully and follow the instructions.

2. Permanent Filtration

The total filtration and the distance between x-ray focal spot and human body are regulated legally.
They should be complied with the regulation.

3. Safety Thermal Switch

X-ray tube assembly has safety thermal switch to prohibit further input power when the tube housing reaches to the temperature of switch-open.

The switch should be hooked up with the x-ray generator which control output power to x-ray tube assembly.

The switch is not recommended connecting stator coil in series circuit.

Even if the switch works, never turn the system power off and the cooling unit should be activated.

4. Unexpected Malfunction

X-ray tube assembly may have the risk to be unexpectedly malfunctioning due to life termination or failure. If the serious problems caused by the above risk is expected, we recommend to have a contingency plan to avoid such a case.

5. New Application

If you use the product with new application not to be mentioned in this specification or with different type of x-ray generator, please contact to us for confirming its availability.

Caution for Installation, Adjustment and Maintenance

1. Qualified Persons

Only qualified persons who have technical training and professional knowledge can handle x-ray tube assembly.

2. Fragile Glass

X-ray tube is assembled with glass, therefore, it can be broken with the mechanical vibration or pulsed shock over 19.6m/s^2 (2G).

Careful handling is required to treat or transport.

3. Ground Terminal

X-ray tube assembly has ground terminal. Ground cable should be connected.

4. High Voltage

All x-ray tubes operate at voltages high enough to kill through electrical shock. Never touch the high voltage delivered plugs or terminals.

When direct access to such parts is required, the primary circuit should be disabled and high voltage capacitors/cables discharged.

5. High Voltage Plug

High voltage plug should be cleaned up and free from any physical damages. Silicon compound application is required for high voltage stability.

6. Operation Atmosphere

X-ray tube assembly is not allowed to use in the atmosphere of flammable or corrosive gas.

7. Protective Cover

X-ray tube assembly is not allowed to use without the protective cover attached.

8. Handling

Appropriate jig or tools are required for tube installation to avoid physical damages.

9. Returning Tube

X-ray tube assembly should be repackaged with the original material when it is returned back for quality examination in our factory.

Be careful to put the tube upside cathode. If the packaging is not proper, the tube may not be correctly examined.

Caution in Operation

1. X-Ray Radiation

X-ray tube assembly should have the beam limiting equipment mounted on the x-ray port to protect unnecessary radiation.

2. Dielectric Oil

X-ray tube assembly has dielectric oil contained for high voltage stability. As it is poisonous for human health, if it is exposed to the non-restricted area, it should be disposed as following to the local regulation.

3. Operation Atmosphere

X-ray tube assembly is not allowed to use in the atmosphere of flammable or corrosive gas.

4. Disposal

X-ray tube housing is lined with lead to protect unnecessary radiation.

The lead powder or vapor is harmful for human health.

Dispose the scrapped products according to the requirement of local regulation.

If you have any questions, please contact to our local sales representatives for further information.

5. X-Ray Tube Housing Temperature

Do not touch on X-ray tube housing surface just after operation due to high temperature.

Stay X-ray tube to be cooled.

6. Any Malfunction

TETD immediately, if any malfunction of the X-ray tube assembly is noticed.

Caution Label

- (a) This label is a caution label to notify the user of the following point.
"Housing end cap is used to protect the electric shock and x-ray leakage."

Attachment position : X-ray tube assembly housing end cap



Maximum Rating Charts (Absolute Maximum Rating Charts)

Conditions: Tube Voltage
Constant potential high-voltage generator
Stator Power Frequency 60 Hz

Nominal Focal Spot :Value: 1.2

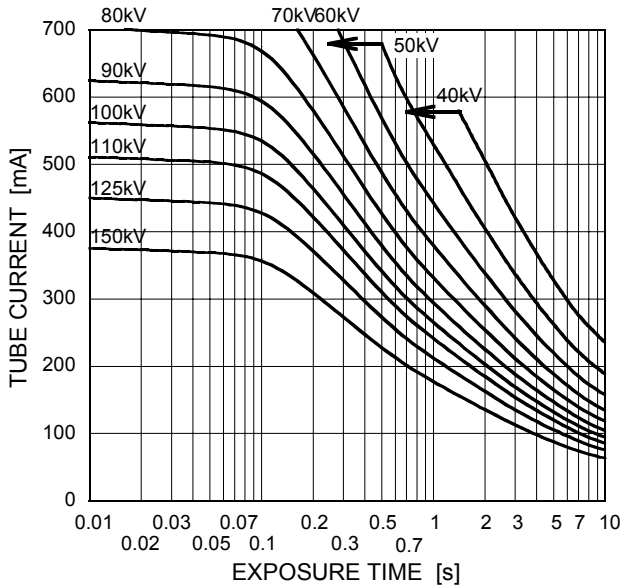

Nominal Focal Spot :Value: 0.6

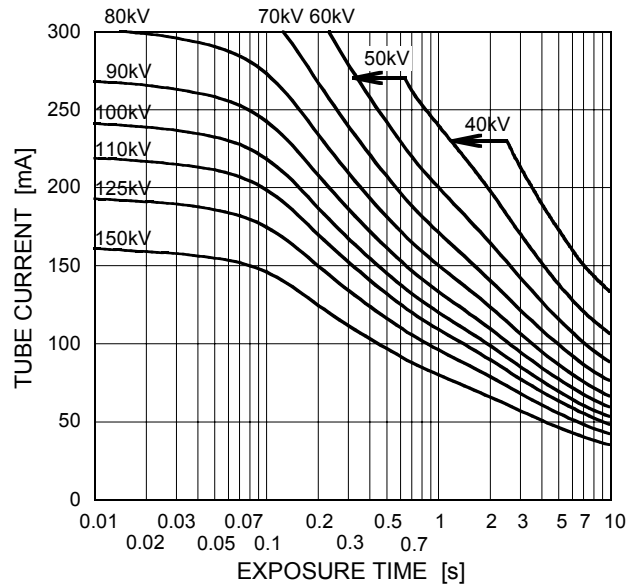

Conditions: Tube Voltage
Constant potential high-voltage generator
Stator Power Frequency 50 Hz

Nominal Focal Spot :Value: 1.2

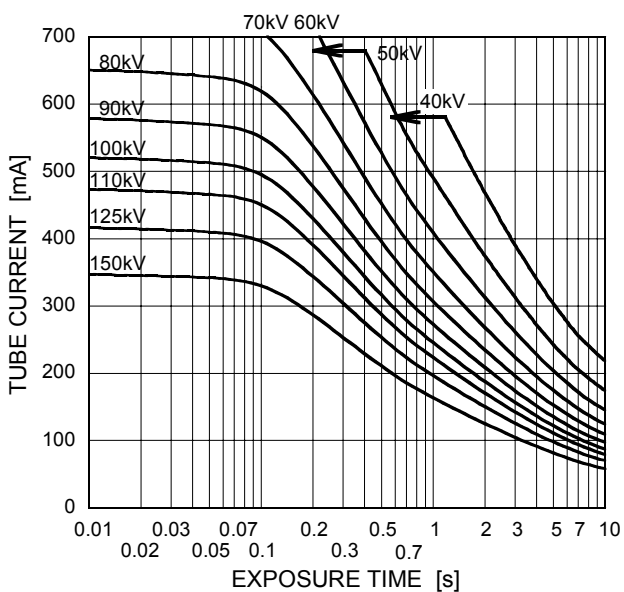

Nominal Focal Spot :Value: 0.6

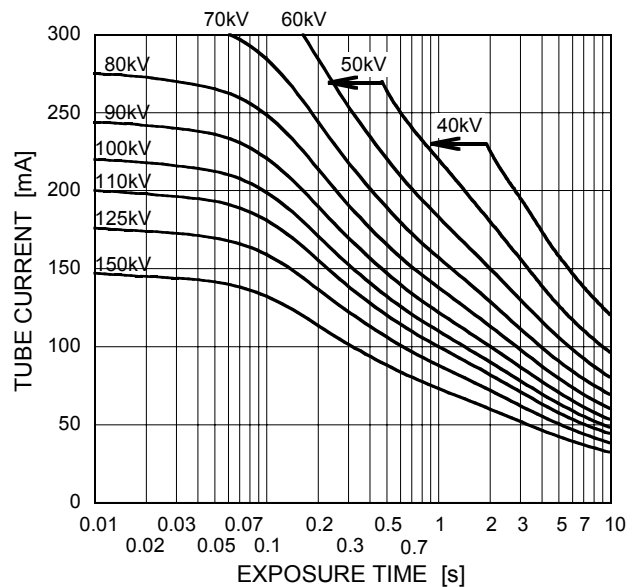

Maximum Rating Charts (Spot-Film Rating Charts)

Conditions: Tube Voltage
Constant potential high-voltage generator
Stator Power Frequency 60 Hz

Nominal Focal Spot :Value: 1.2

Nominal Focal Spot :Value: 0.6

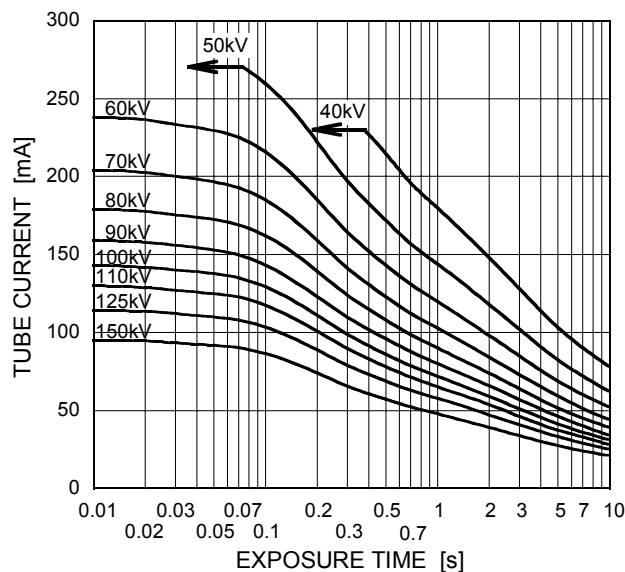
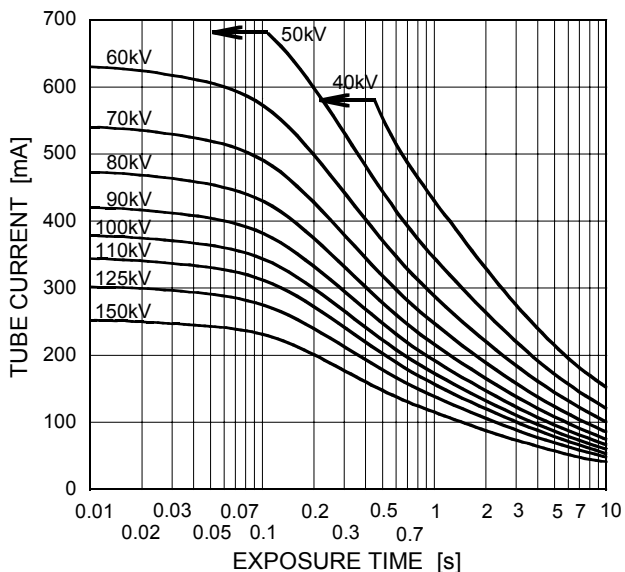

Conditions: Tube Voltage
Constant potential high-voltage generator
Stator Power Frequency 50 Hz

Nominal Focal Spot :Value: 1.2

Nominal Focal Spot :Value: 0.6

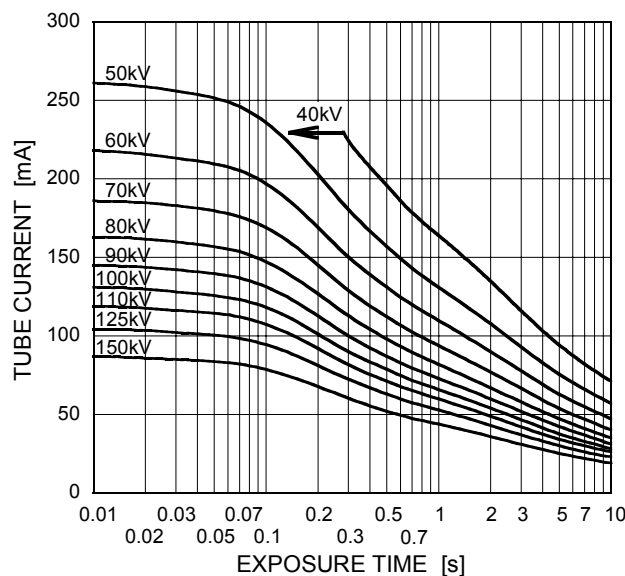
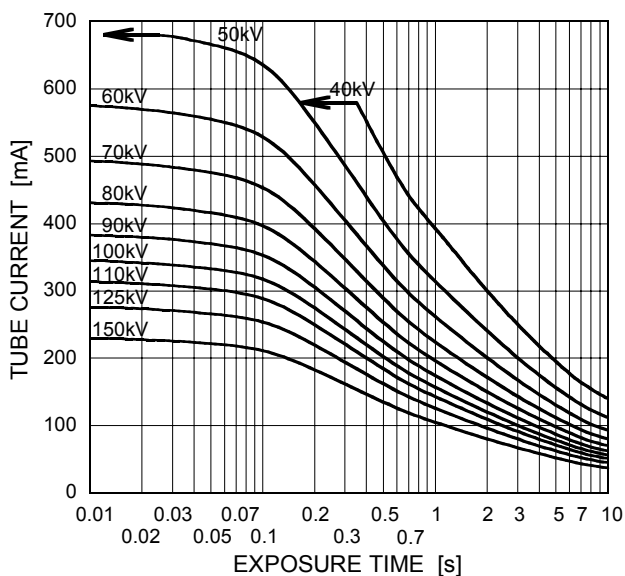

Decreasing input power rating

Serial Load puts a severe thermal stress on the X-ray tube due to the large number of exposures made in rapid succession. Intervals between exposures are fixed and so short that it is not possible for the anode track to cool to any extent during the exposure series.

Therefore, the temperature of the anode track increases from exposure to exposure.

The kW values used in the Serial load at each thermal status of anode have been determined to prevent damage to the anode as follows:

Table1. Radiographic Rating

% HU	kW at 0.1s exposure for 1.2 Nominal Focal Spot Value		kW at 0.1s exposure for 0.6 Nominal Focal Spot Value	
	60Hz	50Hz	60Hz	50Hz
0-5	54.0	50.0	22.0	20.0
6-10	50.0	46.0	20.0	18.3
11-15	50.0	46.0	16.4	15.0
16-20	46.5	42.5	16.4	15.0
21-30	46.5	42.5	16.4	15.0
31-40	34.0	31.0	14.4	13.1
41-50	32.4	29.6	13.7	12.5
51-60	3.8	28.1	13.0	11.9
61-70	29.2	26.7	12.4	11.3
71-80	27.6	25.2	11.7	10.7
81-90	26.0	23.7	11.0	10.0

Table2. Radiographic and fluoroscopic Rating

% HU	kW at 0.1s exposure for 1.2 Nominal Focal Spot Value		kW at 0.1s exposure for 0.6 Nominal Focal Spot Value	
	60Hz	50Hz	60Hz	50Hz
0-10	35.0	32.0	13.0	11.9
11-20	35.0	32.0	13.0	11.9
21-30	35.0	32.0	13.0	11.9
31-40	35.0	32.0	13.0	11.9
41-50	35.0	32.0	13.0	11.9
51-60	35.0	32.0	13.0	11.9
61-70	29.2	26.7	12.4	11.3
71-80	27.6	25.2	11.7	10.7
81-90	26.0	23.7	11.0	10.0

Note: The % HU is the ratio of anode storage heat amount per the nominal anode heat storage capacity (230kHU).

Emission & Filament Characteristics

Three-Phase

Nominal Focal Spot Value: 1.2

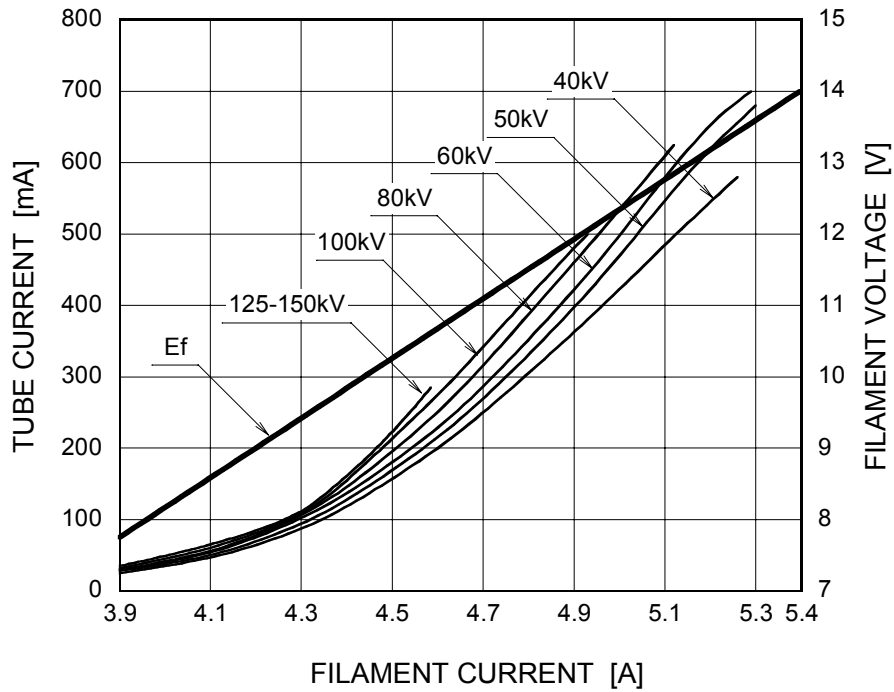

Nominal Focal Spot Value: 0.6

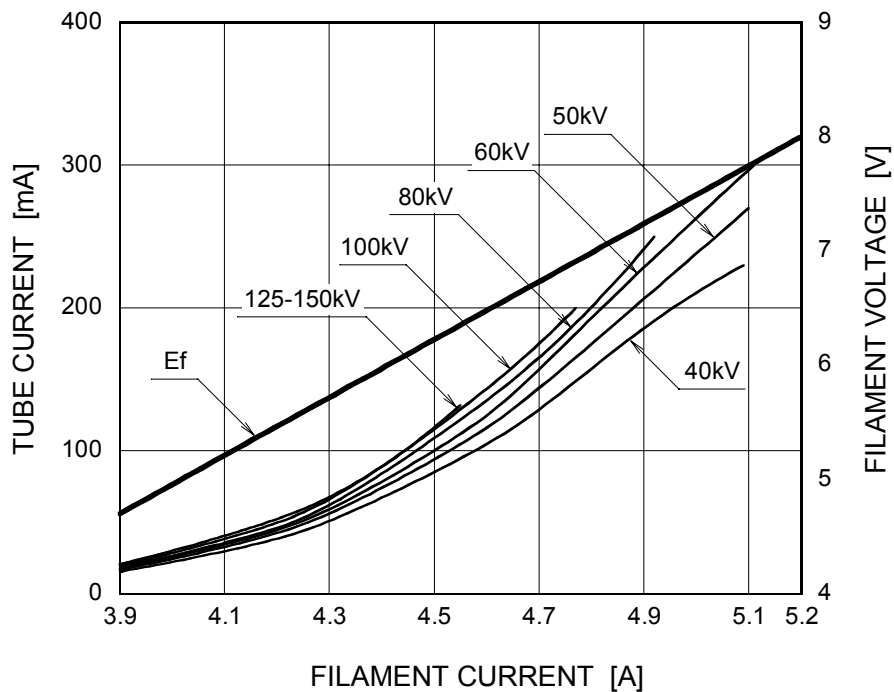

Thermal Characteristics

Housing Thermal Characteristics

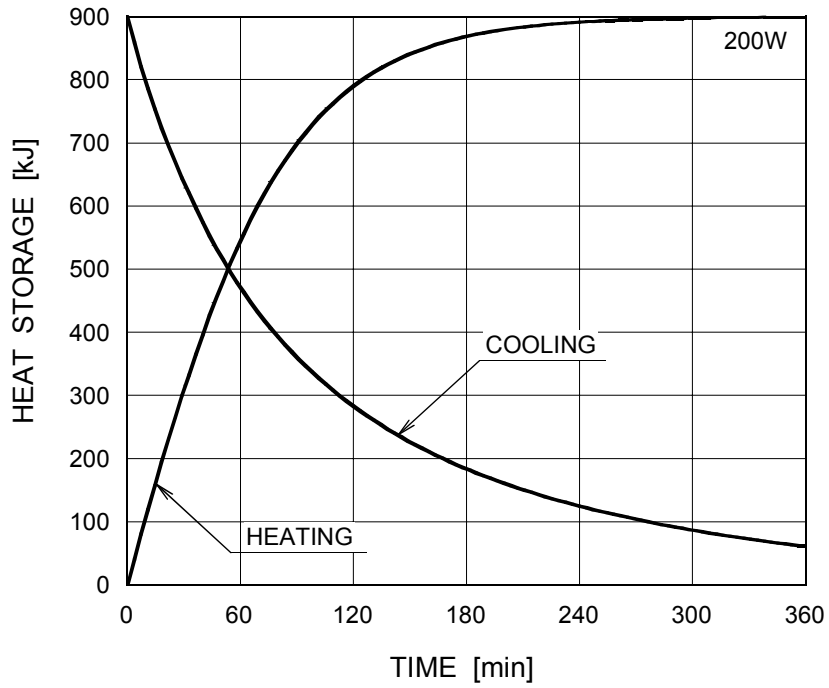

Anode Thermal Characteristics

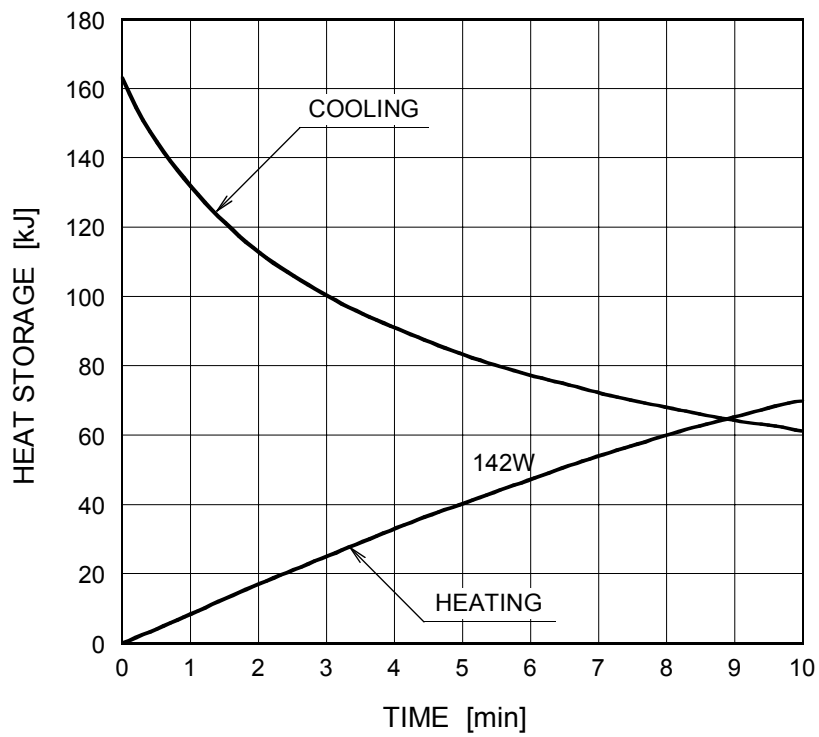

Dimensional Outline

Unit mm

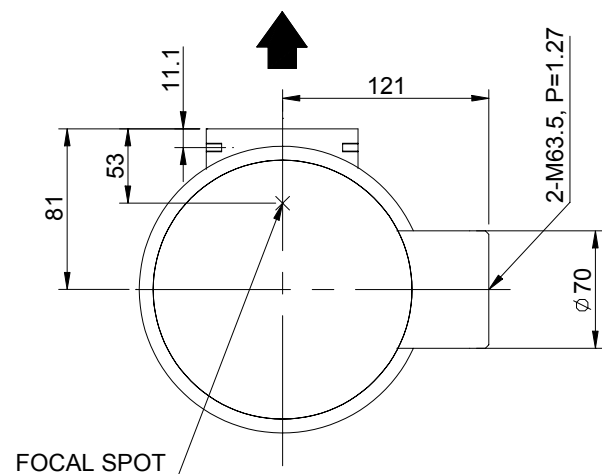
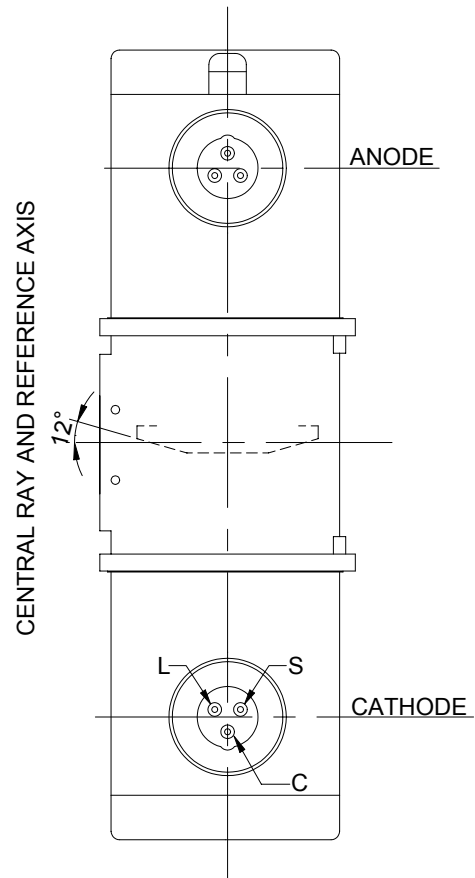
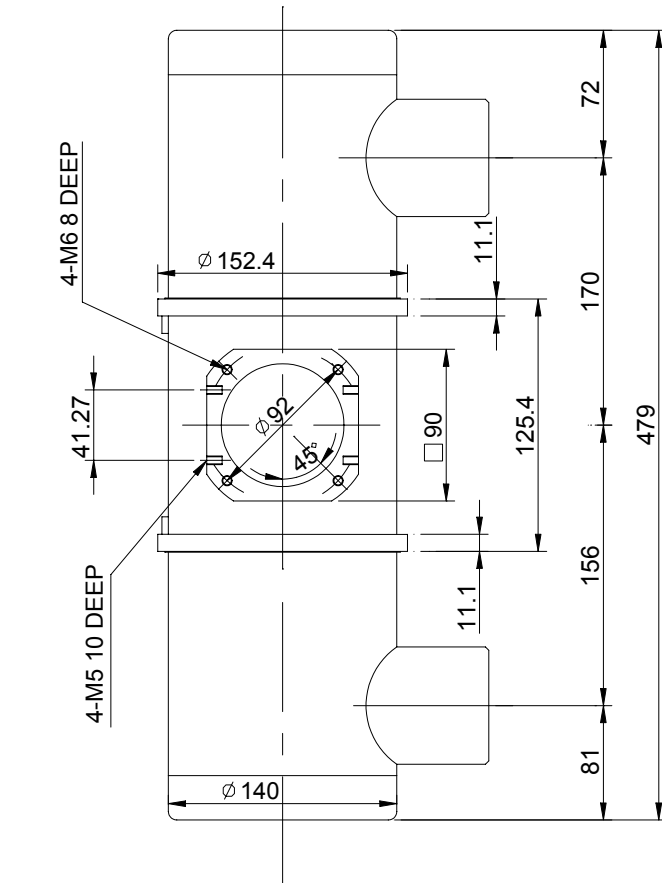

TERMINAL CONNECTIONS

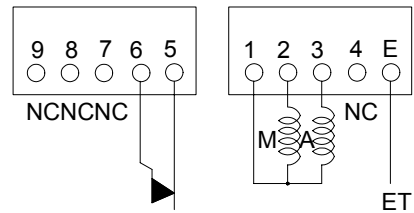

TEMPERATURE RELAY (NORMALLY CLOSED)

Note) Do not connect terminal No.1 and No.5 or 6 in series circuit.

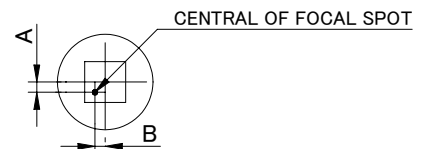

A: ±1.5mm, B: ±1.5mm

C : COMMON
 L : LARGE FOCUS
 S : SMALL FOCUS
 M : MAIN WINDING OF THE STATOR
 A : AUX. WINDING OF THE STATOR

NC : NON-CONNECTION
 ET : EARTH TERMINAL
 ▲ : CENTRAL X-RAY
 ANODE & CATHODE TERMINAL : IEC 60526 TYPE

OVERSEAS SUBSIDIARIES AND AFFILIATES

EU REPRESENTATIVE

• TOSHIBA ELECTRONICS EUROPE GMBH

HANSAALLEE 181 40549 DUSSELDORF, GERMANY
PHONE +49 (0) 211 5296 107 FAX +49 (0) 211 5296 402

For Sales & Technical Services, please contact the following representative:

• TOSHIBA ELECTRONICS EUROPE GMBH

HANSAALLEE 181 40549 DUSSELDORF, GERMANY
PHONE +49 (0) 211 5296 107 FAX +49 (0) 211 5296 402

• TOSHIBA AMERICA ELECTRONIC COMPONENTS, INC.

2150 EAST LAKE COOK ROAD, SUITE 310
BUFFALO GROVE, ILLINOIS 60089 USA
PHONE (847) 484-2400 FAX (847) 541-7287

• TOSHIBA ELECTRON DEVICES & MATERIALS TRADING (SHANGHAI) CO., LTD. (TEMS)

No.689, GUANG DONG RD, SHANGHAI, 200001, CHINA
RM607, HAITONG SECURITIES TOWER
PHONE (21) 6341-0055 FAX (21) 6341-0990

TOSHIBA ELECTRON TUBES & DEVICES CO., LTD.

Sales & Marketing Department

1385 SHIMOISHIGAMI, OTAWARA-SHI, TOCHIGI-KEN, 324-8550, JAPAN

PHONE : +81-287-26-6666 FAX : +81-287-26-6060

<http://www.toshiba-tetd.co.jp/>



Toshiba Electron Tubes & Devices Co., Ltd.
meets the Environmental Management
System Standard, ISO 14001



Toshiba Electron Tubes & Devices Co., Ltd. meets
internationally recognized Standards for Quality
Management System ISO 9001, ISO 13485